

SECURITY SYSTEM



User's Manual

Model: G70-ULTIMATE

IMPORTANT!

PROPER INTRUSION PROTECTION

For proper intrusion coverage, sensors should be located at every possible point of entry to a home or commercial premises. This would include any skylights that may be present, and the upper windows in a multi-level building.

In addition, we recommend that radio backup be used in a security system so that alarm signals can still be sent to the Customer Care Center in the event that the telephone lines are out of order (alarm signals are normally sent over the phone lines).

SYSTEM COMPATIBILITY NOTICE

This security system is designed for use with devices manufactured or approved by us for using with the system. Your system is not designed for use with any device that may be attached to your security system's keypad or other communicating module if we have not approved such device for use with the system. Use of any such unauthorized device may cause damage or compromise the performance of your system and affect the validity of your alarm system limited warranty.

ABOUT THE MANUAL

This manual is a step-by-step guide that will acquaint you with the system's features and benefits. It defines the components and their functions, describes their operation, and provides clear step-by-step instructions for normal and emergency procedures. Keep this manual in a convenient place so that you can refer to it as necessary.

Copyright Notice

This manual is furnished under license and may be used or copied only in accordance with the terms of such license. Except as permitted by such license, no part of this publication may be reproduced, stored in a retrieval system, or transmitted, in any form or any means, electronic, mechanical, Recording, or otherwise, including translation to another language or format, without the prior written permission of Unifore Security. The content of this manual is furnished for informational use only, is subject to change without notice, and should not be construed as a commitment by Unifore Security. Unifore Security assumes no responsibility or liability for any errors or inaccuracies that may appear in this book. All other product names, trademarks and registered trademarks in this document are the properties of their respective holders

Warranty

Unifore Security warrants this product will be free from defects in materials and workmanship for period of time specified on the product packaging. This limited warranty shall commence from the date of purchase. Unifore Security products warranty is not transferable and is limited to the original purchaser. If the product is found to be defective then, as your sole remedy and as the manufacturer's only obligation, Unifore Security will repair or replace the product. The warranty shall not apply to products that have been subjected to abuse, misuse, abnormal electrical or environmental conditions, normal wear and tear or any condition other than what can be considered normal use.

Limitation of Liability

The liability of Unifore Security arising from this warranty and sale shall be limited to a refund of the item price. In no event shall Unifore Security be liable for costs of procurement of substitute products or services, or for any lost profits, or for any incidental, consequential, direct or indirect damages, however caused and on any theory of liability, arising from this warranty and sale. These limitations shall apply not withstanding any failure of essential purpose of any limited remedy.

General System Information

This device is a part of the Unifore Security home control system and works with the bi-directional wireless protocol.

All devices are delivered in a standard configuration. All current technical documents and updates are provided at www.hkvstar.com.

Should you encounter any difficulty in the set-up or operation of your security system, firstly refer to the “Common Problems and Solutions” guide at the rear of this manual. In the unlikely event of a problem occurring with your alarm system, switch off at the mains sockets, pull out the plugs, and contact your dealer immediately.

General Information On Radio Operation

The radio transmission is on a non-exclusive transmission path with possibility of interference occurring. Other interfering sources can be caused by switching operations, electrical motors or defective electrical devices.

The range of transmission within buildings can greatly deviate from open air distances. Besides the transmitting power and the reception characteristics of the receiver, environmental influences such as humidity in the vicinity and local structures also play an important role.

Compatibility Of This Manual

This manual should be used with G70 Series only.

CE & FCC Compliances Statement

CAUTION: Changes or modifications without approved by Unifore Security could void your authority to use this equipment.

This equipment has been tested with the listed standards below and found in compliance with the LVD Directive 2006/95/EC and the EMC Directive 2004/108/EC. It is possible to use CE marking to demonstrate the compliances.

EN 301 489-1 V1.8.1

EN 301 489-7 V1.3.1

EN60950-1: 2006 + A11: 2009 +A1: 2010

EN50131

This product complies with FCC PART 15B / 22H / 24E,
and the operation is subject to the following conditions:

1. This device may not cause harmful interference and
2. This device must accept any interference received



RoHS

Safety Instructions

Before using this product, please read and understand the Safety Instructions thoroughly to ensure correct usage, and follow all the instructions.

Symbols



Special Notes – Please read carefully.

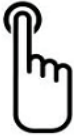

Keypad Control Command – Follow carefully to operate system correctly.

Always follow the manufacturers advice when using power tools, ladders, etc. and wear safety goggles and ear defenders when drilling holes.

It is strongly advised to check for hidden electricity and water pipes with a cable / pipe locator before drilling holes in the desired mounting surfaces.

Mounting all devices in dry interior locations only and away from metalwork, i.e. radiator, water pipes, etc.

Given the high sound level produced by the Siren, when working in close proximity to this device, it is important to wear ear defenders to avoid hearing loss.

Do not overload wall outlets and extension cords as this can result in the risk of fire or electric shock.

Your Quick Guide To System Installations



NOTE: Before proceeding to install your Alarm System, it is important to study your security requirements and plan your installation. For useful installation hints, please refer to the "Installation" section.

Main Alarm Host And Wireless Remote Keypad

1. Turn OFF the alarm panel, before insert a SIM Card.
2. Carefully insert a valid GSM SIM card into the SIM Card Slot located at the rear of the Main Alarm Host

3. Apply AC / DC power to the system with the power adapter provided.

4. Turn on the battery switch located beside the power connector.

5. Position the Alarm Host Anchor Guidance on the desired mounting surface.

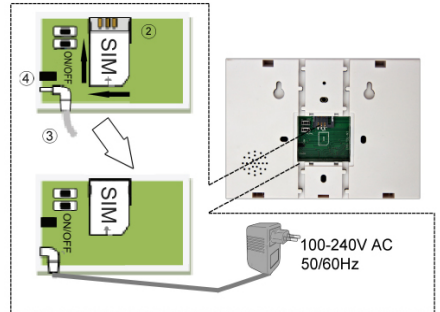

NOTE: When selecting mounting location, avoid fixing any unit onto or very close to metalwork (i.e. radiators, water pipes, etc.) as this could affect the radio range of the device.

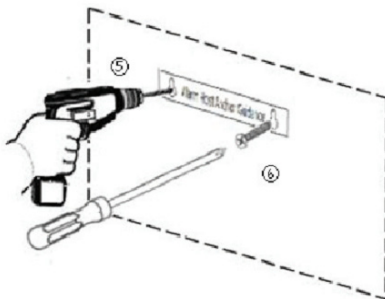

6. Drill two holes, insert wall anchors and fasten with the two screws.

7. Position the Main Alarm Host onto the wall.

8. To install the Wireless Remote Keypad, repeat Steps 3 – 7.

Your Quick Guide to Alarm System Installations (Cont.)

Wireless Wide-Angle PIR Sensor

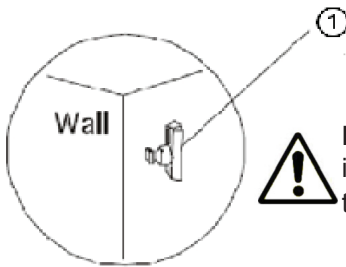

1. Use the mounting bracket to mark two drilling holes in the corner of a room mounted at a height of between 2 and 2.4 meters. Drill the holes and fit two screws provided to fix the bracket.

NOTE: Do not drill the fixing holes with the bracket in position. The power tool may cause damages to the bracket.

2. Undo and remove the screw located at the bottom edge of the Sensor. Open the sensor shell to remove jumper for a detection frequency of every 5 minutes.

3. Connect the battery supplied to the battery clip. Refit the cover and fixing screw.

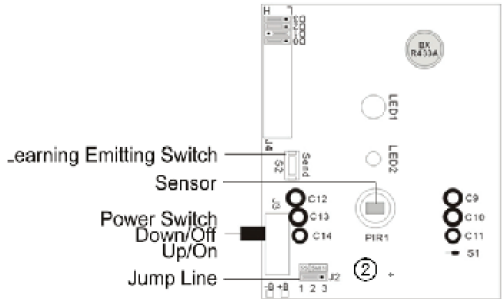

4. Slide the PIR sensor into the bracket. Adjust the sensor to an angle that the movement of an intruder would cut across the device.

5. Connect the PIR sensor to battery and the unit will enter into the normal working state after 30 seconds.

Wireless Door Sensor

1. Slide off the battery cover and place the provided battery into battery holder with “+” facing upward and refit the battery cover.

2. Attach the adhesive pads onto the back of the magnet and detector.

3. Mount the detector on the frame and the magnet on the opening part at a height of at least 1.6 meters.

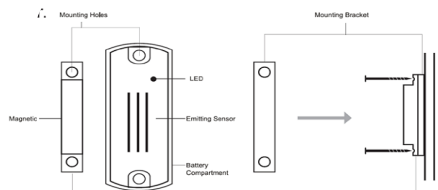

NOTE: The magnet must be aligned on the LEFT side parallel to the detector and within 10 mm to the sensor when the door / window is closed.





Indoor Wireless Siren

1. Plug the Internal Siren into a suitable indoor mains socket at a height above 1.8 meters

Your Quick Guide To System Operation

Key Buttons

Main Alarm Panel and Wireless LCD Keypad

- Arming Away  + Password* + ENT + Armed Away + ENT
- Arming Home  + Password* + ENT + Armed Home + ENT
- Emergency 
- Disarming & Stopping Alarm  + Password* + ENT

Wireless Keypad

- Arming Away  Emergency
- Arming Home  Disarming & Stopping Alarm  

Phone/SMS







Includes stopping an alarm by telephone and remotely arming / disarming by telephone / SMS, please refer to the “Securing The Protected Site” for more details.

* The alarm panel employed a User Code (default: 888888) for “Arm”, “Disarm” and “Set” operations. The Wireless Remote Keypad is double password protected and operates with a User Code (default: 111111) for “Arm / Disarm” and a Prog. Code (default: 888888) for “Set” operations. You are strongly advised to change the Default Codes to Personal Codes IMMEDIATELY. See “Setting Your Passwords” for more details.

System Luminous Signal Indicators







Alarm control panel



-   On – No GSM network detected (or SIM card not available). Flashing – GSM detected.
Slow flash: 200ms on, 2s or 3s off indicates the Main Alarm Host is in standby mode.
Fast flash: 200ms on, 600ms off indicates the Main Alarm Host is dialing the programmed numbers.
-   On – Armed (Home or Away). Flashing – Smart sensor open detected. Off – Disarmed.
-   On – AC connected (normal). Flashing – Working with backup battery. Off – Low backup battery.



Wireless Remote Keypad



-  When the Main Host is armed as “Armed Home” mode,  light will turn on together with the  light.
-  When the Main Host is armed as “Armed Away” mode, only  light will turn on.
-  On – AC connected (normal). Flashing – Working with backup battery.
Off – Low backup battery

Useful Hints For Users

Stopping An Alarm

A triggered alarm can be stopped by   + Password on the Main Alarm Host (default: 1111) or Wireless Remote Keypad (default: 111111) or by using the Wireless Remote. To stop an alarm remotely, press the “ * ” button after receiving the call from your system, the system will remain Armed and the next number will not be called. By SMS message, send a message “XXXX0” to the Main Alarm Host. XXXX is your 4-digit User Code on the Main Alarm Host. The system will be Disarmed and a confirming message will be sent.

Emergency, Perimeter and Motion Zones

Sensors set to the Emergency zone will trigger an alarm in Armed / Disarmed mode upon disturbance. Sensors linked to the Perimeter zone can only trigger an alarm when the system is in Armed mode (Home / Away). Sensors programmed to the Motion zone could only trigger an alarm in “Armed Away” mode.

System Testing

With the system in standby mode, user could trigger each sensor or accessory one by one. The triggered unit will be shown on the Main Alarm Host without triggering an alarm.

SMS Reporting

By programming a private number to be the 1st caller number (Call Center Number) and if the upload status has been enabled, you will be able to receive system information such as “Arm”, “Disarm”, Alarm or AC failure.

Telephone Alarm

If an alarm was triggered and providing a valid GSM SIM card is present, the system will automatically contact the programmed telephone numbers in the system. Upon receiving the call, the recorded voice message is played immediately for 30 seconds repeatedly. User has the following options:

Press “ 8” to enter into the listening status and hear the alarm background sounds for 20 seconds.

Press “ #” to play the recorded voice message again

*Press “ *”, the Main Alarm Host will end the call and stop dialing the next Auto Dialer Number. The system will return to “Arm” status.*

Directly hang off the phone, the Main Alarm Host will end the call and automatically dial the next Auto Dialer Number.

Chime Function

By allocating a sensor to the Chime zone, whenever a sensor in that zone is triggered in the standby mode, the system will produce a few “bi” sound to alert the user. Please refer to “Set Smart Zone” for more details.

Introduction

Overview

G70-ULTIMATE is the state-of-the-art LCD touchpad wired / wireless alarm system for home and office security. Its aesthetic design with a user friendly illuminated LCD menu and a touchpad control provides a new standard of security alarm system and makes your home works in a Hi-Tech style. You can install the system and monitor your home / office all by yourself or via a security center service with Ademco CID protocol. G70-ULTIMATE secures your property for you, while you enjoy your life.



NOTE: This manual is designed to familiarize you with the G70-ULTIMATE security alarm system.

We strongly recommend you read the manual before using your system.

System Arming

Your G70-ULTIMATE is controlled by a Main Alarm Panel designed to collect data from sensors located within the protected site. The system provides user with protection options of “Armed Home” and “Armed Away”. “Armed Home” will arm all zones while the “Armed Away” will only arm the Perimeter zone. An alarm is triggered upon detection of disturbance in any one of the armed zones. Sensors and detectors set to the Emergency zone could also trigger an alarm regardless of the system is being armed or disarmed.

SMS Alert / Phone Call To Preset Numbers And Call Center

In the event of alarm being triggered, the system will automatically report the event via SMS alert (if GSM is available) or phone call to the Call Center and preset telephone numbers in the dialing sequence until an acknowledge signal is received.

User and Master Codes

G70-ULTIMATE Main Alarm Host employs a 6-digit User Code for “Arm”, “Disarm” and “Set” operations. Wireless Remote Keypad is double password protected and operates with a 6-digit User Code for “Arm” / “Disarm” and a 6-digit Prog. Code for “Set” operations. It is recommended that only the Master User has access to the programming functions (“Set” operation) of the system and to the Main Alarm Host.

Bypass Zones

With the bypass sensor function, a zone could be omitted upon arming. Any sensors allocated to the bypassed zone will not be protected and will not trigger an alarm.

Zones

The system could monitor 31 wireless zones (supporting up to 124 wireless accessories) and 8 wired zones. Each zone could be independently allocated into one of these types:

- **Perimeter (Outer Zone Defense):** Generally use for detecting area such as doors, windows, etc.; Wireless Door Sensors and Wireless Curtain PIR Sensors are normally allocated into this zone.
- **Motion (Inner Zone Defense):** Generally use for detecting area such as living room, aisles and bedrooms etc., Wireless Wide-angle PIR Sensors and Wireless Door Sensors are normally allocated into this zone.
- **Emergency:** This zone monitors the system status for 24-hour and is usually used for emergency distress, medical rescue, gas leakage, smoke and fire alarm, etc. Sensors including Panic Button, Wireless Gas Sensors and Wireless Smoke Detectors are normally allocated into this zone.

Remote Phone And SMS Control

It is possible to gain basic control (Arming / Disarming the system) over the system by dialing into the system or by sending a SMS message. You may also activate the microphone on the Main Alarm Host to Listen-In to what is happening in the protected property. With a personal number set to the 1st Caller number and upload status is enabled, an SMS notification message will be sent to the user to confirm a status change of the system when conducted remotely.

Entry / Exit Delay

The system has up to 60 seconds of Entry and Exit delay functions. No signal from any sensor will be able trigger an alarm until the Exit delay is expired. This provides enough time for user to exit the property without triggering an alarm.

If the user leaves the property after the Exit delay, the system will enter the Entry delay countdown and user will need to enter the user code to disarm the system and avoid triggering an alarm. If the Entry delay function is disabled for the certain zone, an alarm will be triggered immediately once the system is armed.

System History Records

The system is capable of storing up to 100 alarm records and 100 Arm / Disarm records. This enables the user to review the time and date an alarm is triggered and when the system is Armed / Disarmed. With E2PROM data management, the system is capable of retaining programming settings and event logs after power is disconnected.

Touchpad control with LCD illumination display

The system has a stylish touchpad control panel that displays status information, time and date in large, clear letters.

Chime Function

If a sensor is allocated to the Chime zone, and the sensor is triggered when the system is in standby mode, the Main Alarm Host will produce a few “bi” sound to alert the user that a door or a particular area has been entered.

Installation

It is strongly recommended to plan your security arrangement prior to the installation of your security system. For your convenient, ALL accessories delivered with your system will be registered to the Main Alarm Host to provide a basic functional system. User has the flexibility to assign their own configuration if necessary (Zones 00 – 01, 31 – 38 are fixed zones). To program the system, please refer to “Program Sensors” section. The table provided in Appendix A at the end of this manual will assist you to register your owned settings, such as the intended location of each detector, the holder and assignment of each transmitter. Please refer to “Your Quick Guide To System Installations” for picture instructions

Below is the suggested installation locations for different units, use it as a guide for planning your alarm system.

Units \ Location	Primary	Secondary	Additional
Door Sensor	Front Door	Back Door / Patio Doors	Vulnerable Doors / Windows / Access Doors To Important Rooms
Wide-Angle PIR Sensor	Hallway Covering The Main Alarm Host (Or Wireless Control Keypad)	Main Living Room / Access Route Between Bedrooms	Study / Bedrooms / Landing
Indoor Siren	Living Room	Hallway	Bedroom
Smoke Detector	Kitchen Ceiling	Living Room Ceiling and Aisles	Important Areas



NOTE: *It is important to examine whether the selected sensor locations will cover all your security requirements. If necessary, make any sensors rearrangement and / or purchase additional sensors for additional protection.*

Main Alarm Host And Wireless Remote Keypad



Your G70 is controlled by a Main Alarm Host designed to collect data from various sensors within the protected site. Wireless Remote Keypad is designed to interact with the Main Alarm Host and to use for daily operations. The system is capable of monitoring up to 39-zone and has an auto-learn sensor function for easy addition of remotes, detectors and sensors. You should consider the following before proceeding to installation.

- Preferably using the Wireless Remote Keypad for your daily operations and keep the Main Alarm Host in a safe location within reach of a mains socket and out of sight of potential intruders.
- Mount the Wireless Remote Keypad at a convenient location and out of children reach, i.e. Place it at a height above 1.5 meters.
- Locate your Main Alarm Host and Wireless Remote Keypad within a protected area, i.e. Any intruder must open a protected door or pass through a PIR sensor when the system is armed.
- The selected location for the Main Alarm Host must have a good GSM signal and for G70 models (G70-GT/GTW) with telephone based functions, it must be situated within reach of a telephone point.
- Avoid mounting the Main Alarm Host and Wireless Remote Keypad close to any metalwork, i.e. Radiators, water pipes, etc., as the radio range of the device could be affected.

Installing The Main Alarm Host and Wireless Remote Keypad

SIM Card Connection



NOTE: Clear ALL password, messages and contacts on the SIM Card before use. Do not insert or remove SIM card when the system is powered by AC power or Battery.

Insert a valid GSM SIM card in correct direction into the SIM Card Slot located at the rear of the Main Alarm Host.

Phone Line Connection

Connect one end of the telephone line cord into the Main Alarm Host and the other end of this cord into the wall jack.

Power Connection



NOTE: Use only the G70 power supply provided with your system. The Main Alarm Host and Wireless Remote Keypad have different power adapter in their packing box, please be careful not to apply the wrong adapter.

Apply AC / DC power to the system with the power adapter provided. Connect to AC100-240V, 50/60Hz. Plug the connector into the rear of the Main Alarm Host. Same for the Wireless Remote Keypad.

Backup Battery Charging

A rechargeable Li-Ion battery is installed in the Main Alarm Host. To recharge, turn on the battery switch located beside the power connector. Same for the Wireless Remote Keypad.

Check GSM Signal Level

In standby mode



▲ or ▼ button on the Main Alarm Host



“XX” is the signal level, 2-digit, “00” ... “31” indicates the signal from weak to strong. “99” indicates unknown.

“YY” is the signal status, display either “OK” or “NO”.

“OK” means the signal is fine and the host is working properly.

“NO” means the signal is weak and user should adjust the installation place of the Main Alarm Host.

If the SIM card is not present or not correctly installed, then the panel will show “NO SIM CARD”.

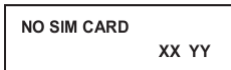

ESC to exit, or the system will exit automatically after 30 seconds.

Remote Keyfob

Overview And Hints

The Remote keyfob is used for daily operations, such as Arming and Disarming the system. It also incorporated an Emergency button, which will trigger an alarm, even in Disarmed mode, upon activation. The alarm could be stopped with the Disarm button on the Wireless Remote, at the Main Alarm Host or at the Wireless Remote Keypad.

When using a Wireless Remote, the following should be considered:

- The expected battery life for the Wireless Remote is approximately 1 year. However, you should replace the battery as soon as you feel the system does not respond to the unit properly upon pressing the buttons.
- Keep the unit safely. If the unit is lost, delete the unit from the Main Alarm Host immediately.

Wireless Wide-Angle PIR Sensor

Overview And Hints

The Wireless Wide-Angle PIR Sensor is designed to monitor and control indoor space. With the system in Armed mode and PIR sensor activated for the protected area, a rapid changes in infra-red radiation levels will trigger an alarm.

When using a Wireless Wide-Angle PIR Sensor, the following should be considered:

- To conserve power and maximize battery life, user should only set the detection frequency to 5 seconds mode when programming the sensor and to 5 minutes mode when used daily.
- For best results, position the sensor in the corner of a room mounted at a height between 2 and 2.5 meters.
- Ensure the Wireless Wide-Angle PIR Sensor is within effective range of the Main Alarm Host.
- Avoid mounting the sensor directly above or very close to a heat source, i.e. fire, radiator, etc.
- Try positioning the sensor in the corner of the room that covers the logical path of an intruder

Installing The Wireless Wide-Angle PIR Sensor

1. Undo the fixing screw located at the bottom edge of the sensor.
2. Carefully remove the front cover away from the rear cover.
3. Connect the battery supplied to the battery clip.
4. To set the detection frequency, on the Jump Line, join 1 – 2 or 2 – 3 with a jumper for a detection frequency of
- 5 seconds (for programming a sensor) or 5 minutes (for daily operation), respectively.
5. Refit the front cover to the rear cover by first clipping the top edge together followed by pushing the bottom edge together. Finally, refit the fixing screw in the bottom edge of the sensor.
6. Turn on the sensor by positioning the ON / OFF switch located at the side edge of the sensor to ON.
7. Using the mounting bracket as a template, mark and drill the positions of the fixing holes in a corner or against a flat wall.
8. Fix the mounting bracket to the wall and slide in the sensor. Adjust the angle if required

Wireless Door Sensor

Overview And Hints

The Wireless Door Sensor comprises of a sensor and magnet. With the magnet normally mounted on the door / windows and the sensor mounted to the frame, the Wireless Door Sensor is designed to send a signal to the Main Alarm Host in order to trigger an alarm in Armed mode upon the protected door or window is opened.

When using a Wireless Door Sensor, the following should be considered:

- You are recommended to have your front and back doors fitted with a Wireless Door Sensor. Depended on your security requirement, fit additional door sensors to other vulnerable doors / windows if required.
- Ensure the Wireless Door Sensor is within effective range of the Main Alarm Host.

Installing The Wireless Door Sensor

1. Remove the battery cover at the left side of the sensor.
2. Slide the battery supplied into the battery holder, with “+” facing upward
3. Refit the battery cover and mount the unit using the double sided adhesive pads



NOTE: Ensure the mounting surfaces are clean and dry before mounting.

Internal Siren

Overview And Hints

The Internal Siren acts as a wireless spot alarm, which receives alarm signal from the Main Alarm Host. The siren has a power plug and produces both sound and flash alarm when triggered.

When using an Internal Siren, the following should be considered:

It is recommended to have the Internal Siren at a height above 1.8 meters.

Installing The Internal Siren

1. Plug the Internal Siren into a suitable indoor mains socket at a height above 1.8 meters.

Smoke Detector

Overview And Hints

The Smoke Detector is designed to monitor smoke caused by fire. The Smoke Detector is activated 24-hour to protected the area and will trigger an alarm upon detection of a smoke.

Installing The Smoke Detector

1. Use the mounting bracket to mark two drilling holes on the wall. Drill the holes and fit two screw provided to fix the bracket.
2. Remove the battery cover and connect the provided battery to the battery clip.
3. Refit the battery cover. Slide in the detector and rotate clockwise to lock the detector onto the mounting bracket.



NOTE: Do not drill the fixing holes with the bracket in position. The power tool may cause damages to the bracket.

Factory Settings

Main Alarm Host







- Master Code 888888
- Wireless Code 00001
- Auto-Dialer#'s Not programmed
- Entry Delay OFF, 0 second
- Exit Delay ON, 15 seconds
- Alarm Time
 - Emergency ON, 1 minute
 - Perimeter ON, 1 minute
 - Motion ON, 1 minute
- Arm / Disarm Beep ON
- User ID 0001
- Upload Status NO
- Zone Attribute See "**Zone Attribute**" for the default zone allocation and recommended sensors.

Wireless Remote Keypad

- Master Code 888888
- User Code 111111
- Wireless Code 11111111

Securing The Protected Site

Security – Related Buttons

Unit	Key	Function
Main Alarm Host / Wireless Remote Keypad		Arming the system, both for Away and Home Arming.
		Triggering an alarm immediately (for emergency use).
		Disarming the system and stopping alarms.
Wireless Remote		Arming when nobody is at home.
		Arming when people remain at home.
		Disarming the system and stopping alarms.
		Triggering an alarm immediately (for emergency use).
Phone	Password + 1	Arming remotely when nobody is at home.
	Password + 0	Disarming remotely when nobody is at home.
SMS	Password + BF	Arming remotely when nobody is at home.
	Password + CF	Disarming remotely when nobody is at home.

System Arming

  To arm the system using the Wireless Remote:

  button for the “Armed Home” mode.

To arm the system using the Main Alarm Host / Wireless Remote Keypad. In standby mode:

 0 + Password + ENT

 ▲ or ▼ button to choose “Armed Home” or “Armed Away” + ENT



NOTE: The default user password for the Main Alarm Host and the Wireless Remote Keypad are 888888 and 111111, respectively.

In “Armed Away” mode, all sensors can trigger the alarm when system is armed.

In “Armed Home” mode, only the sensors set in the Perimeter zone can trigger the alarm when system is armed.

To arm the system remotely by Phone:

Call the phone number associated to the system, you will hear one “ bi ” sound after connecting to the system. Within 30 seconds after connection, enter the user password (default is 888888) of the Main Alarm Host. Enter “ 1 ” after another “ bi ” sound, the Main Alarm Host will automatically hang up after the “ bi ” sound to complete the operation.



NOTE: Arm by phone only has “Armed Away” option!

To arm the system remotely by SMS:

Send the SMS message "XXXXXXBF" from your mobile phone to the Main Alarm Host. XXXXXX is the 6-digit user password (default is 888888) on the Main Alarm Host. The Main Alarm Host will arm the system automatically upon receiving this SMS and reply with a message "System Armed" when the system is successfully armed.



NOTE: Arm by phone only has "Armed Away" option!

Initiating An Emergency Alarm

An emergency alarm is triggered upon pressing the button on the Wireless Remote or on the Main Alarm Host /Wireless Remote Keypad.

By Wireless Remote:

 the Main Alarm Host will alarm immediately.

By Main Alarm Host / Wireless Remote Keypad:

 the Main Alarm Host will alarm immediately.

System Disarming And Stopping An Alarm

In any case, a triggered alarm could be stopped by disarming the system.

To disarm the system using the Wireless Remote:

 the Main Alarm Host will beep twice to exit from any Armed mode.

To disarm the system using the Main Alarm Host / Wireless Remote Keypad:

 ESC + Password + ENT

The Main Alarm Host will beep twice to successfully complete the operation.



NOTE: The default user password for the Main Alarm Host and the Wireless Remote Keypad are 888888 and 111111, respectively.

To disarm the system remotely by Phone:

Call the phone number associated to the system, you will hear one “ bi ” sound after connecting to the system. Within 30 seconds after connection, enter the user password (default is 888888) of the Main Alarm Host. Enter “ 0 ” after another “ bi ” sound, the Main Alarm Host will automatically hang up after the “ bi ” sound to complete the operation.

To disarm the system remotely by SMS:

Send the SMS message “XXXXXXCF” from your mobile phone to the Main Alarm Host. XXXXXX is the 6-digit user password (default is 888888) on the Main Alarm Host. The Main Alarm Host will disarm the system automatically upon receiving this SMS and reply with a message “System Disarmed” when the system is successfully disarmed.



NOTE: If you input the code 3 times incorrectly, the Main Alarm Host will return back to the standby mode.

Stopping An Alarm Without Disarming The System

If an alarm was triggered by an intruder and providing a valid GSM SIM card is present, the system will automatically contact the programmed telephone numbers in the system. Upon receiving the call, user could stop the alarm by pressing the “ * ” button. The system will remain “Armed” and stop dialing the next auto dialer number.

Forced Arming (Smart Sensor)

When Arming the system, if a protected zone is programmed to be a smart zone (With Smart Door Sensors VS-PWMC only), The Main Alarm Host / Wireless Remote Keypad will flash to indicate a zone is disturbed. You will be asked if you want to continue arming the system. If you choose “YES”, the system will arm with the smart zone bypassed and the protected site will not have maximum protection.

Setting Your Passwords

Main Alarm Host

G70 Main Alarm Host employed a User Code for “Arm”, “Disarm” and “Set” operations, default is 888888.

To modify the user code on the Main Alarm Host:

 SET + Master Password (Default is 999999) + ENT.

Enter a 6-digit new code + ENT and re-enter the new code + ENT for confirmation.

Wireless Remote Keypad

The Wireless Remote Keypad (VS-WJP2) also has a User Code for “Arm” and “Disarm” operations, default is 111111, but uses a Prog. Code for “Set” operation, default is 888888. The reason for this arrangement is that it gives authority to the administrator only to modify items in “Set” while other users in the same premises can only use “Arm” and “Disarm” operations from the Wireless Remote Keypad.

To modify the user / prog. code on the Wireless Remote Keypad:

 SET + Master Password (Default is 999999) + ENT.

Select between User Code and Prog. Code, enter the current password + ENT.

Enter a 6-digit new code + ENT and re-enter the new code + ENT for confirmation



NOTE: The Master Password (999999) for changing the user / prog. codes could not be changed.

Recording / Playing A Message

Your G70 has a built in microphone and loudspeaker on the Main Alarm Host. The recorded message is used for playback in an alarm event.

To record a message:

Press and hold the record button (located at the back of the Main Alarm Host) and speak closely to the mic hole located on the panel. Release the button once finish recording. The system can store a 10 seconds long message.

To play a message:

Press the play button (located at the back of the Main Alarm Host) and you can hear the recorded message.

Upon receiving the call from the system after an alarm was triggered, the recorded voice message is played immediately for 30 seconds repeatedly. User could select from the following options:

Press “ 8 ” to enter into the listening status for 20 seconds, you can hear the alarm background sounds from phone.

Press “ # ” to play the recorded voice message for one more time.

Press “ * ”, the Main Alarm Host will end the call and stop dialing the next auto dialer number. The system will return to “Armed” mode.

Directly hang off the phone, the Main Alarm Host will end the call and automatically dial the next auto dialer number.

Programming – Main Alarm Host

Your G70 is configured to provide a basic functional alarm system, but the ready-to-use alarm system will still need a few settings and adjustments.

Entering The Program Mode

Access to the Program Mode menu on the Main Alarm Host is protected by a User Code (default is 888888).

To enter the program mode:

 SET + Enter User Code + ENT

 ▲ or ▼ button to choose from the following:



NOTE: It is strongly recommended that only the Master User has access to the programming functions (“Set” operation) of the system and to the Main Alarm Host.

Program Mode Main Menu



Set Time	Upload Status?
Set Date	CutWire Alarm?
Auto-Dialer#'s	Zone Attribute
Entry Delay	Set Smart Zone
Exit Delay	Program Sensor
Siren On/Off	Wireless Code
Arm/Disarm Beep	Alarm History
User ID	Status History

Time / Date Settings

Set the time and date displayed on the Main Alarm Host.

Set Time



In program mode, when Set Time is displayed:

 ENT +  Use button to delete the old record, then input HHMMSS + ENT

HHMMSS: 6-digit, meaning hour (HH), minute (MM), second (SS), each takes 2 digits space. For example 14:21:20, you may press 142120 and the time shown on the Main Alarm Host will be 14:21:20. For invalid time, it cannot be saved by pressing ENT.

Set Date

In program mode, when Set Date is displayed:

 ENT +  Use button to delete the old record, then input YYMMDDW + ENT

YYMMDDW: 7-digit, meaning year (YY), month (MM), day (DD), week (W, “ 0 ” means Sunday). For example 17th December, 2012, Thursday, you may press 1212174 and the date shown on the Main Alarm Host will be 17th December, 2012, Thursday.

Auto Dialer Number

To set the reporting telephone numbers or reporting SMS. First Auto Dialer Number is for Call Center use and the remaining Auto Dialer Numbers are for Personal Numbers.

- Call Center** – Report to a Call Center with Ademco CID protocol or a specified number to report status of the system (**Arm / Disarm / Alarm / AC Failure**). Please note you will also need to enable the “**Upload Status?**” function. See “**Upload Status?**” below for detailed operations.
- Personal Number** – Only reports when system is in alarm.
- Call By Phone** – For Voice alarming. When system is in alarm, it will dial the pre-installed numbers.
- SMS Reporting** – For SMS alarming. If you choose “**SMS Reporting**”, system sends a SMS message to the telephone numbers (with GSM), but not to land line numbers.

In program mode, when Auto Dialer#’s is displayed:

ENT +  Use button to delete the old record, then input the 1st telephone number + ENT

▲ or ▼ button to select the report method (“Call By Phone” / “SMS Reporting”) + ENT

Repeat steps for 2nd phone number, 3rd phone number etc. In total you can program up to 5 phone numbers.



NOTE: Users could set a private number to the 1st telephone number (Call Center Number) if they are monitoring the system themselves.

Entry / Exit Delay

To set the entry or exit delay time of alarm, this option allows you to disarm or arm the system in a limit time.



NOTE: Only available for sensors set to Perimeter and Motion zones. (See “Zone Attribute” section below for setting zone arrangement.)

Entry Delay

In program mode, when Entry Delay is displayed:

ENT +  Use button to delete the old record, then input set XX + ENT

XX: 2-digit, you can set an entry time delay between 00~59 seconds, default is “00”. “S” shown at the bottom left of the screen indicates the value is in second.

Exit Delay

In program mode, when Exit Delay is displayed:



ENT +  Use button to delete the old record, then input set XX + ENT

XX: 2-digit, you can set an exit time delay between 00~59 seconds, default is “15”.

Turn Siren On / Off

This option allows you setting the siren to alarm or mute when sensors are triggered. For your options, the system has independent setting for the 3 zones (Perimeter, Motion and Emergency zones). See “Zone Attribute” section below for setting zone arrangement.

In program mode, when Siren On/Off is displayed:

 ENT +  Use button to delete the old record in Emergency zone, then set the alarming duration time (minutes) XX + ENT

Repeat step for Perimeter and Motion zones.

XX: 2-digit, you can set a siren time between 00~60 minutes, defaults are “ 01 ” (1 minute) for Emergency, Perimeter and Motion zones. “ M ” shown at the bottom left of the screen indicates the value is in minute.



NOTE: If the time is set to M = 00 for a particular zone, then the siren will be set to mute mode for this zone.

Arm / Disarm Beep

This option allows you to choose whether to have a short siren sound when arming or disarming the Main Alarm Host.



In program mode, when Arm / Disarm Beep is displayed:

 ENT + Use ▲ or ▼ button to select “YES” or “NO” (Default is “YES”) + ENT

User ID

This is used to identify the system number for a security call center (Individual user can ignore this setting).

In program mode, when User ID is displayed:

 ENT +  Use button to delete any old record, then set XXXX + ENT

XXXX is the User ID, you can set to a 4-digit number between 0000 and 9999. Default user code 0001.

Upload Status

This is used when you want the system status such as Arm, Disarm, Alarm and AC power failure to be reported to the Call Center number. If you are monitoring the system by yourself, this function will report any status changes in the system by SMS message to the Call Center number (which is set to your mobile number).

In program mode, when Upload Status? is displayed:

 ENT + Use ▲ or ▼ button to select “YES” to enable this function (Default is “NO”) + ENT

Cut Wire Alarm

This option is to set the alarm if the telephone land line is being cut off.

In program mode, when CutWire Alarm is displayed:

 ENT + Use ▲ or ▼ button to select “YES” to enable this function (Default is “NO”) + ENT

Zone Attribute



The system is managed by allocating the accessories into “Zone Number”, “Zone Type”, “Alarm Type”, “Bypass Zone” and “Entry Delay Set”. Below shows the default zone allocation and recommended sensors, user has the flexibility to assign their own configuration if necessary (Zone 00 – 01, 31 – 38 are fixed zones).

Zone Number	00,01	02	03	04	05	06	07	08	09	10	11	12	13	14	15	16	17	18	19	
Zone Type	Emergency					Perimeter							Motion							
Alarm Type	Remote	00	01	02	03	08	08	08	08	07	07	07	07	10	10	10	10	10	13	13
Recommended Accessories	Remote / Keypad	Panic Button	Gas	Smoke	Wireless Door Magnet & Curtain PIR				Wireless Infra-Red Beam Detector				Wireless Wide Angle PIR Motion Sensor				Other Wireless Sensor			
Zone Number	20	21	22	23	24	25	26	27	28	29	30	31	32	33	34	35	36	37	38	
Zone Type	Motion											Perimeter			Motion		Emergency			
Alarm Type	13	13	11	11	11	14	14	14	14	20	09	09	09	06	06	03	03	03		
Recommended Accessories	Other Wireless Sensor		Wireless Wide Angle PIR Motion Sensor			Other Wireless Sensor				Door Bell	Wired Door Magnet & Curtain PIR		Other Wired Sensor		Wired Smoke Sensor					

Zone Number

The system has 39 zones in total. 29 wireless zones (each zone supports up to 4 sensors), 8 wired zones (optional) and 2 dedicated zones for remotes (supports up to 4 Wireless Remotes or Wireless Remote Keypads per zone).

In program mode, when Zone Attribute is displayed:

 ENT +  Use button to delete any old record+ XX (2-digit Zone Number between 02~38) + ENT

Zone Type

The system must be allocated into one of the following 3 zones:

- Perimeter (Outer Zone Defense): Generally use for detecting area such as doors, windows, etc.; Wireless Door Sensors and Wireless Curtain PIR Sensors are normally allocated into this zone.
- Motion (Inner Zone Defense): Generally use for detecting area such as living room, aisles and bedrooms etc., Wireless Wide-angle PIR Sensors and Wireless Door Sensors are normally allocated into this zone.
- Emergency: This zone monitors the system status for 24-hour and is usually used for emergency distress, medical rescue, gas leakage, smoke and fire alarm, etc. Sensors including Panic Button, Wireless Gas Sensors and Wireless Smoke Detectors are normally allocated into this zone.

 ▲ or ▼ button to select the Zone Type + ENT

Three types: “ 2 ” means Motion zone, “ 1 ” means Perimeter zone, “ 0 ” means Emergency zone

Alarm Type

The corresponding sensor name will then show on the LCD and SMS when alarm is triggered. Alarm Type 20 is specially allocated for door bell function.



ENT +  Use button to delete any old record+ + XX + ENT

XX: 2-digit, you can set 00~15 or 20 for valid Alarm Type.

Alarm Type	00	01	02	03	04	05	06	07	
Sensor Name	Panic 1	Panic 2	Gas	Smoke	Door	Window	Wired	IR	
Alarm Type	08	09	10	11	12	13	14	15	20
Sensor Name	Perimeter 1	Perimeter 2	Motion 1	Motion 2	Motion 3	Sensor 1	Sensor 2	Sensor 3	(Door Bell)

Bypass Zone

This setting is to enable or disable a zone.



▲ or ▼ button + ENT

Choose “YES” to bypass (disable) the sensor, choose “NO” to keep this zone’s sensors working. Default is “NO”.

Entry Delay Set

This setting is to enable or disable entry delay for the zone.



▲ or ▼ button + ENT

Choose “YES” if you want the sensors in this zone to have entry delay, choose “NO” if you want the alarm to go off immediately when any of the sensors in this zone is triggered, regardless of the entry delay time setting. Default is “NO”.

Set Smart Zone

This is a brand new feature in G70 system. The smart sensor recorded in the system can determine if a door / window is opened or closed upon arming. If the Main Alarm Host detects a door with smart sensor is opened, the system arm status will flash to indicate. You will be asked if you want to continue to arm anyway.



NOTE: Only workable with the Wireless Smart Door Sensor (VS-WPWMC). To order, please visit our company website at www.hkvstar.com.

In program mode, when Set Smart Zone is displayed:



ENT +  Use button to delete any old record,select a desired Smart Zone Number XX + ENT



▲ or ▼ button to select “YES” or “NO” on the menu + ENT

Choose “YES” to set the zone as a smart sensor zone. Choose “NO” to keep the zone in normal working mode. Default is “NO” for all zones.

The Main Alarm Host then requires you to confirm whether the sensor (door / window) is currently opened or closed.



▲ or ▼ button to select “OP” or “CL” on the menu + ENT

Choose “OP” let the Main Alarm Host knows the sensor (door / window) is currently opened. Choose “CL” let the Main Alarm Host knows the sensor (door / window) is currently closed. Default is “CL” for all zones.

Door Chime Function

Finally, you have the option to enable or disable a sound indicator (Chime Function) when a sensor in this zone is being triggered in the standby mode.



 ▲ or ▼ button to select “YES” or “NO” in the Zone Indicator menu + ENT

Choose “YES” then the Main Alarm Host will provide a few “bi” sound to indicate a sensor in this zone is being triggered in the standby mode. Choose “NO” if you do not want a sound indication when a sensor in this zone is being triggered in the standby mode. Chime function works for both the normal and smart sensors.

Program Sensors



This setting is for adding, changing or deleting sensors in all zones (including Zone Number 00, 01).

To activate a sensor, in Program mode, when Program Sensor is displayed:

 ENT +  Use button to delete old “Zone Number”, then set XX + ENT

XX : 2-digit, for valid operation you can set a Zone Number between 00~38 (See “Zone Attribute” for more details).

As each zone can accompany up to 4 sensors, defined as 0, 1, 2 or 3. A Group Number must be selected.

 ENT +  Use button to delete the previous “Group Number”, then set X + ENT

X : 1-digit, for valid operation you can set a Group Number from one of the followings: 0, 1, 2 or 3.

Activating / Updating A Sensor

To activate a sensor,

 ▲ or ▼ button to select “Activate Sensor” + ENT



Note: If the word “Update?” shows on the screen, it means this sensor has already been added before, choose “Yes” to override the previous setting for this sensor in the system or “No” to keep the setting unchanged.

Deactivating A Sensor

To deactivate a sensor, follow the same procedure and select “Delete Sensor” + ENT

This option allows you to delete the added sensors from the Main Alarm Host. The words “Deleting Success” will show on the LCD Screen, which means you have deleted the sensor successfully from the system.

Wireless Code

This option allows user to change the unique wireless code for transmission on the Main Alarm Host. It is used so that every G70 Main Alarm Host can have a different transmission code to avoid unintentional transmission to your neighbor's G70 system.



NOTE: You do not need to change this code if there is no nearby user using the G70 system. If you change this code after matching the accessories to the Main Alarm Host, you will need to re-match the accessories or change back to the previous wireless code for them to work.



SET + Enter User Code (default password is 888888) + ENT



▲ or ▼ button to choose Wireless Code



ENT +  Use button to delete any old record, then set XXXXX (5-digit unique wireless code between 00000 – 99999. Default is "00001") + ENT

Programming – Wireless Remote Control

Entering The Program Mode Menu

Access to the Program Mode menu on the Wireless Remote Keypad is protected by a Prog. Code (default 888888).

To enter the program mode:



SET + Enter code (default password is 888888) + ENT



▲ or ▼ button to choose from the following:

NOTE: VS-WJP2 Wireless Remote Keypad is double password protected and operates with a user code for ARM / DISARM and a prog. code for SET operations. Default user and prog. code is 111111 and 888888, respectively.

Program Mode Main Menu
Set Time
Set Date
Main Unit Sync
Wireless Code



Time / Date Settings

Set Time

In program mode, when Set Time is displayed:



ENT +  Use button to delete the old record, then input HHMMSS + ENT

HHMMSS: 6-digit, meaning hour (HH), minute (MM), second (SS), each takes 2 digits space. For example 14:21:20, you may press 142120 and the time shown on the Main Alarm Host will be 14:21:20. For invalid time, it cannot be saved by pressing ENT.

Set Date

In program mode, when Set Date is displayed:



ENT +  Use button to delete the old record, then input YYMMDDW + ENT
YYMMDDW: 7-digit, meaning year (YY), month (MM), day (DD), week (W, " 0 " means Sunday).

Main Unit Synchronization

This option allows the Wireless Remote Keypad to receive status information from Main Alarm Host.



NOTE: The original Wireless Remote Keypad that is shipped with your G70 system will be automatically registered to the Main Alarm Host. Unless you made any changes to the Wireless Code, on the Main Alarm Host or Wireless Remote Keypad or both, re-matching the Wireless Remote Keypad to the Main Alarm Host is not required.

Activating the Synchronization

To activate, in program mode, when Main Unit Sync is displayed:



ENT + Use the ▲ or ▼ button to choose “Activate” + ENT,

The word “Learning” will show on the LCD Screen, trigger the Main Alarm Host followed by disarming on the Main Alarm Host, the word “Success” will show on the LCD screen once the Wireless Remote Keypad receives the signals from the Main Alarm Host.

Deactivating the Synchronization

To delete, in program mode, when Main Unit Sync is displayed:



ENT + Use the ▲ or ▼ button to choose “Delete” + ENT,

The word “Success” will show on the LCD screen.

Wireless Code

In program mode, when Wireless Code is displayed:



ENT +  Use button to delete old record, then set XXXXXXXX + ENT

XXXXXXXX : 8 digits, digits range from 0, 1 or 2. Default is 11111111.



NOTE: You do not need to change this code if there is no nearby user using the G70 system. If you change this code after matching the Wireless Remote Keypad to the Main Alarm Host, then signal could not be transferred to the Main Alarm Host again. You have to re-match the Wireless Remote Keypad or change back to the previous wireless code for them to work.

Reviewing Alarm / Status History

The system could memorize up to 100 records, both for the alarm and status history. User could review the alarm and status history one by one when needed.



NOTE: The system will automatically replace the oldest events log once the records are filled up.

Alarm History

In program mode, when Alarm History is displayed:

 ENT + Use ▲ or ▼ button to view record + ENT

Status History

In program mode, when Status History is displayed:

 ENT + Use ▲ or ▼ button to view record + ENT







Daily Maintenance and Care

This alarm is a hi-tech product with the outstanding design and sophisticated technique, and shall be used carefully.

To make the alarm to operate for a long term stably and to prolong the service life, it is recommended that:

1. Try to put the Main Alarm Host in a dry and well-ventilated location.
2. Do not put the Main Alarm Host and any wireless detectors in too cold, too hot or dusty places to prevent it from curtailing the service lives of electric parts and preventing the plastic shell from distorting.
3. Do not put the Main Alarm Host and any wireless detectors in low and too exposed places to prevent children from touching them or the thieves from finding them.
4. Regular testing is necessary for finding and resolving problems in time. Regularly check the batteries in all wireless sensors. The service life of the battery is approximately 1 year. To ensure normal operations of the system, replace with new batteries whenever you feel a sensor is not detecting properly.

Quick Guide on How to Activate /Deactivate Wireless Accessories

Sensor Type	How to activate	How to deactivate
Remote Keypad (Zone 00, 01)	<ol style="list-style-type: none"> 1) SET + Password + ▲ or ▼ "Program sensor" + ENT +  + Zone Number Y Y + ENT +  + Group Number X + ENT + ▲ or ▼ "Activate Sensor" + ENT ("Learning" will be shown) 2) Press  on the remote twice successively, the main host LCD will display "Success" 	<ol style="list-style-type: none"> 1) SET + Password + ▲ or ▼ "Program sensor" + ENT +  + Zone Number Y Y + ENT +  + Group Number X + ENT + ▲ or ▼ "Delete Sensor" + ENT 2) The alarm host will beep once and press ESC to exit.
Remote (Zone 00, 01)	<ol style="list-style-type: none"> 1) Same as above 2) Press  on the remote twice successively, the main host LCD will display "Success" 	Same as above
Wireless door sensor	<ol style="list-style-type: none"> 1) Same as above 2) Trigger the door magnet sensor twice successively 	Same as above
Wireless smart door sensor	<ol style="list-style-type: none"> 1) Same as above 2) Trigger the door magnet sensor twice successively 3) Go to <i>Set Smart Zone</i> to activate smart zone. 	Same as above
Wireless Wide-Angle PIR sensor	<ol style="list-style-type: none"> 1) Same as above 2) Trigger the PIR sensor by pressing "Learning Emitting Switch" on the panel twice successively 	Same as above
Wireless Curtain PIR sensor	<ol style="list-style-type: none"> 1) Same as above 2) Trigger the PIR sensor by pressing "Learning Emitting Switch" on the panel twice successively 	Same as above
Wireless Gas detector	<ol style="list-style-type: none"> 1) Same as above 2) Trigger wireless gas alarm by releasing gas, the host LCD will display "Success" 	Same as above
Wireless Smoke Sensor	<ol style="list-style-type: none"> 1) Same as above 2) Trigger wireless smoke alarm by releasing smoke, the host LCD will display "Success" 	Same as above
Wireless Indoor siren	<ol style="list-style-type: none"> 1) After connecting to the power, press the "Learning" switch on the side of the siren 2) Press  key on the alarm host (not the remote) to sound off the siren, then disarm by using the alarm host keypad (ESC + Password + ENT), the alarm host will beep twice to indicate the indoor siren has been successfully disarmed. 3) The siren light will flash 5 times and then off indicates successful activating 	<ol style="list-style-type: none"> 1) After connecting to the power, keep pressing the "Learning" switch on the side of the siren for 5 seconds and release, light on the siren flashes 2 times and then off indicate successful deactivating
Wireless Outdoor Siren	Same as wireless indoor siren	Same as wireless indoor siren

Wired Accessories Connection Instruction

How To Connect Wired Sensors To The Main Alarm Host

- Normal Closed (NC) type sensors

Sensor with self power supply

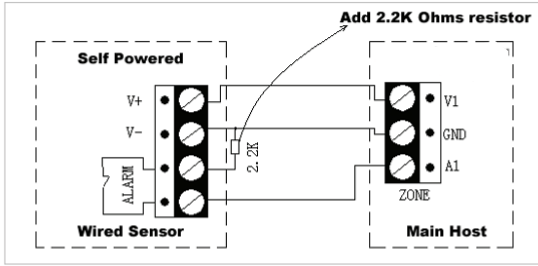

Sensor without self power supply

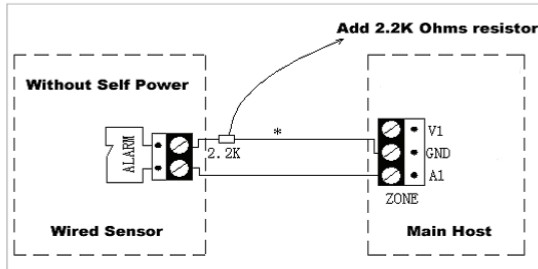

- Normal Open (NO) type sensors

Sensor with self power supply

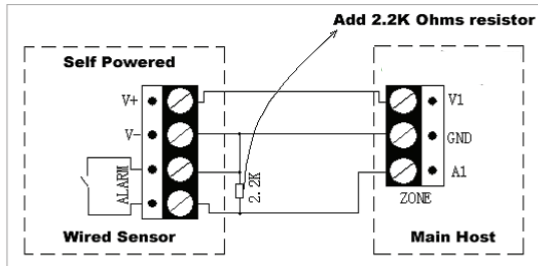

Sensor without self power supply

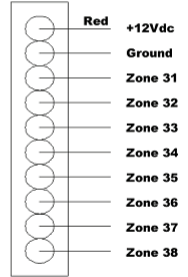
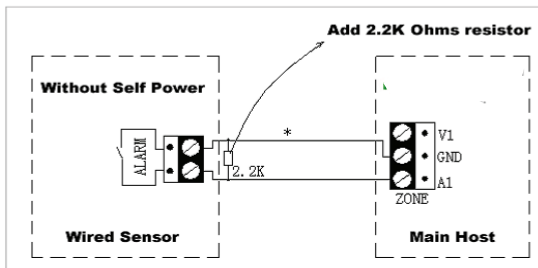

Common Problems and Solutions

Symptoms of Faults	Possible Cause	Solution
The alarm host goes off immediately after connected to the power	The telephone incoming line has not been connected or not well connected.	Connect the telephone incoming line well.
The alarm host can't record playback message.	The record button is not pressed correctly.	1. Press the record button while recording, maximum message length is 10 seconds.
Repeatedly receiving the alarm telephone	Fail to operate according to the operation instruction of the telephone alarm.	Follow the instructions after answering the alarm phone calls and hearing the recorded message. (See Recording / Playing A Message And Sound Control)
The host does not alarm after the detector is triggered in arm state	1. Caused by the functions of arm mode (Armed Away and Armed Home). 2. Have already setup time for <i>Entry Delay</i> or <i>Exit Delay</i> .	1. " Armed Away " mode: the alarm goes off when any sensor is triggered. 2. " Armed Home " mode: the alarm goes off when any sensor in perimeter zone is triggered and it won't alarm when any sensor in motion zone is triggered. 3. Program to adjust the time for <i>Entry Delay</i> or <i>Exit Delay</i> .
The PIR sensor doesn't work	1. Not connected to the power. 2. Low battery. 3. Did not match to the main host.	1. Open the sensor shells to install the battery and turn on power switch. 2. " 5S ": detect once every 5 seconds; " 5MIN ": detect once every 5 minutes. 3. Match the sensor to the main host according to " Program Sensors " instruction.
The detecting distance of PIR sensor gets shorter	1. The ambient temperature is too high. 2. Low battery.	It is normal that when the ambient temperature in the detecting area exceeds the human body temperature, the detecting distance will get shorter.
The host does not alarm after the new added wireless detector is triggered.	Failed to follow the operation instruction of " Program Sensors " to add the new wireless sensor.	Follow the operation instruction of " Program Sensors " to activate the new wireless sensor.
The PIR sensor flashes frequently in green.	Low battery.	Replace with new batteries of the same specification.
The door magnetic sensor indicator flashes frequently in green after alarming.	Low battery.	Replace with new batteries in the same specification.
The distance of the remote controller gets shorter.	Low battery.	Replace with new batteries in the same specification.
The host does not alarm after the new added wireless detector is triggered.	Failed to follow the operation instruction of " Program Sensors " to add the new wireless sensor.	Follow the operation instruction of " Program Sensors " to activate the new wireless sensor.

UNIFORE SECURITY

Shangtang Commercial Building, Mingzhi, BaoAn
Shenzhen, China

Copyright © 2012 Shenzhen Meidasi Technology Development Co., Ltd.

www.hkvstar.com